



Lasting Connections

PPE & ACCESSORIES CATALOGUE 2021/22



voestalpine Böhler Welding
www.voestalpine.com/welding

voestalpine

ONE STEP AHEAD.



As a passionate developer of innovative products we are the ideal partner and solution provider for safe welding. We put the welder's daily challenges and highest expectations into the center of our activities. This creates trust into our products and guarantees effective protection, outstanding quality and excellent comfort in accomplishing the welder's tasks.

CONTENT

Personal Protective Equipment 5

WELDING HELMETS 6

WELDING RESPIRATORY SYSTEMS 10

WELDING GLOVES 14

EYEWEAR 17

ARC Welding Accessories 19

WELDING TOOLS 20

WELDING CHEMICALS 21

WELDING BLANKETS 22

JOIN! voestalpine Böhler Welding 25



PERSONAL
PROTECTIVE
EQUIPMENT

WELDING HELMETS

Guardian helmets are designed for a wide range of welding and grinding applications. In the focus of product development is the welders' expectation for high-quality, comfortable and durable products. This means light weight products down to 480 grams with a robust headgear covered by soft sweatbands and highest ADF clarity with true colour technology.

Guardian⁶² - designed for highest expectations:



Variable Shade

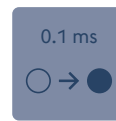

Switching Speed at 23 C/73.4 F



Grind Mode



True Colour

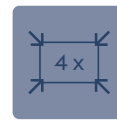

Four Sensors



EN379 - classification

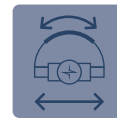

Comfort Headgear



Quick release ADF Cartridge

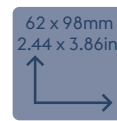

Large Viewing Area



Light Weight

WELDING HELMETS

Guardian⁵⁰

High Impact Nylon Shell
Comfort-Headgear with longitudinal and angular adjustments, smooth ratchet
ADF: Shade 4, 9-13, 50 x 100 mm viewing area and 4 arc sensors
True colour
EN 379 classification 1/1/1/2
Grind mode via external switch

Guardian⁵⁰

32371



Guardian⁶²

High Impact Nylon Shell
Comfort-Headgear with longitudinal and angular adjustments, smooth ratchet
ADF: Shade 4, 5-9/9-13, 62 x 98 mm viewing area and 4 arc sensors
True colour with Best-In-Class-Clarity
EN 379 classification 1/1/1/2
Grind mode via external switch
Lightweight at 480 gram

Guardian⁶²

32373



Guardian⁶² - La Catrina (Special Edition)

High Impact Nylon Shell
Comfort-Headgear with longitudinal and angular adjustments, smooth ratchet
ADF: Shade 4, 5-9/9-13, 62 x 98 mm viewing area and 4 arc sensors
True colour with Best-In-Class-Clarity
EN 379 classification 1/1/1/2
Grind mode via external switch
Lightweight at 480 gram

Guardian⁶² La Catrina (Special Edition)

72394



Guardian^{62F}

This welding helmet combines the technical advantages of the Guardian⁶² with a flip-up mechanism. The perfect solution for welding and grinding applications.

Guardian^{62F}

32374



WELDING HELMETS TO USE WITH BÖHLER RESPIRATORY SYSTEMS



Guardian⁶² Air

Welding helmet with adjustable air outlets inside the helmet, face-seal and air duct.
ADF: Shade 4, 5-9/9-13, 62 x 98 mm viewing area
EN 379 classification 1/1/1/2

Guardian⁶² Air

57007



Guardian^{62F} Air

Flip-up welding helmet with adjustable air outlets inside the helmet, face-seal and air duct.
ADF: Shade 4, 5-9/9-13, 62 x 98 mm viewing area
EN 379 classification 1/1/1/2

Guardian^{62F} Air

57029

Two main air streams for an optimized clean air supply to the breathing zone



Adjustable outlet to easily adjust the airflow to your forehead

SPARE PARTS FOR ALL WELDING HELMETS

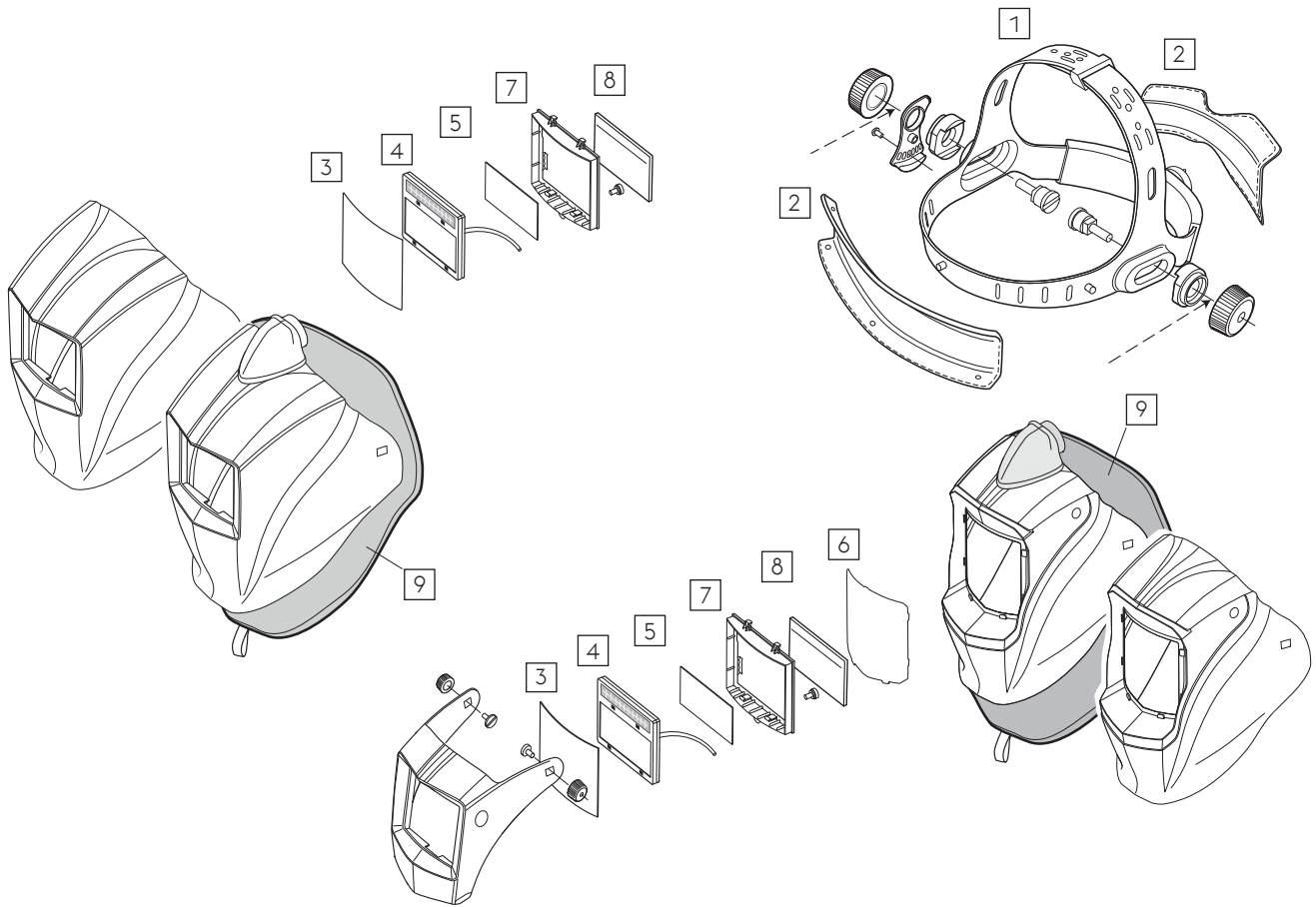

Product Name	Guardian helmet					
	50	62	62F	62 Air	62F Air	
1 Headgear Böhler	•	•	•	•	•	32406
2 Sweatband (Front and rear)	•	•	•	•	•	32416
3 Front cover lens (10 pieces)	•	•	•	•	•	32423
4 ADF Guardian ^{62, 62F} (excl. battery ADF CR2450)		•	•	•	•	63635
5 Inner lens Guardian ⁵⁰ (5 pieces)	•					32425
Inner lens Guardian ^{62, 62F} (5 pieces)		•	•	•	•	32433
6 Grinding visor Guardian ^{62F} (2 pieces)			•		•	32437
7 ADF retainer and screw Guardian ^{62, 62F}		•	•	•	•	32442
ADF retainer and screw Guardian ⁵⁰	•					32443
8 Diopter 1.0	•	•	•	•	•	32444
Diopter 1.5	•	•	•	•	•	32445
Diopter 2.0	•	•	•	•	•	32452
Diopter 2.5	•	•	•	•	•	32456
9 Helmet face seal				•	•	57182
* Battery ADF CR2450	•	•	•	•	•	32517

*not pictured in the graphic above

WELDING RESPIRATORY SYSTEMS

BÖHLER Air

BÖHLER Air is our Powered Air-Purifying Respiratory (PAPR)-System that provides the welder with the best protection against particles and fumes related to welding and grinding applications. It supplies the welder with a constant airflow. The system is equipped with an audio, visual and vibration alarm to inform the user about low battery as well as clogged filters. BÖHLER Air is tested and certified according to EN12941 with the highest protection class TH3.

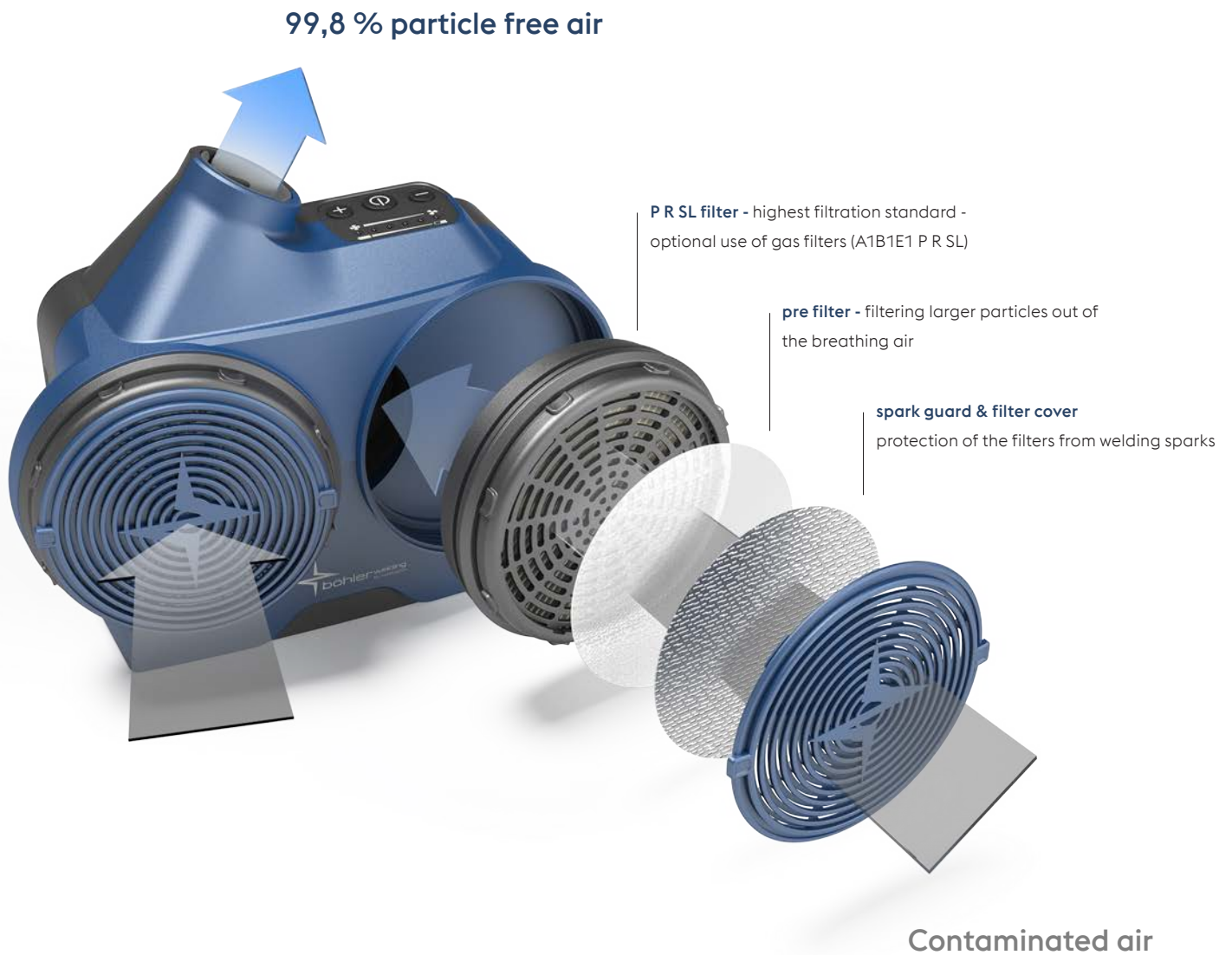



User Benefits



For a reliable protection of your respiratory tract



Fast & easy filter change - for an extended protection against harmful gases



Shoulder harness for an ergonomic wearing comfort and an ideal weight distribution



Ensures an operating time of up to 14 hours



Stay and be safe - with a visual, audible and vibrating warning system



For a perfect airflow setting according to your personal need

Technical Specifications

- » Particle filters (P R SL) or optional use of gas filters (A1B1E1 P R SL)
- » Standard: EN 12941 protection class TH3
- » Operating time: Up to 14 h for the heavy-duty battery 7.800 mAh (new P R SL filters, fully charged battery and lowest air flow)
- » Flow rate 180 - 230 l/min - adjustable at 6 levels
- » Warning system (alarm): Visual, audible and vibrating warning for low airflow and/or low battery charge
- » Flow control system maintains level of airflow constant regardless filter clogging or battery charge
- » High quality ball-bearing brushless motor
- » Exchangeable Li-Ion Battery 7.4 V / 7.800 mAh / 57,72 Wh - 6 cells
- » Charging time: 8 - 9 hours - battery lifespan will decrease to 80 % after 500 charging cycles
- » Universal charger microprocessor controlled: 100 - 240 V (50/60 Hz)

WELDING RESPIRATORY SYSTEMS



BÖHLER Guardian^{62 Air} Complete

A full and ready to use kit of the BÖHLER Air (Complete Blower Kit) with a Guardian^{62 Air} helmet in a comfortable BÖHLER bag.

BÖHLER Guardian^{62 Air} Complete

56997



BÖHLER Guardian^{62F Air} Complete

A full and ready to use kit of the BÖHLER Air (Complete Blower Kit) with a Guardian^{62F Air} flip-up helmet in a comfortable BÖHLER bag.

BÖHLER Guardian^{62F Air} Complete

57003



BÖHLER Air (Complete Blower Kit)

Ready to use kit, including motor unit, flexible air hose, heavy-duty battery (7.800 mAh), universal charger, comfort belt, shoulder harness, P R SL filters and pre-filters, spark guards and airflow tester.

BÖHLER Air (Complete Blower Kit)

57037



Supplied Air *

A ready to use kit of the Supplied Air respiratory system for pressured air supply. To be used in combination with Guardian^{62 Air} or Guardian^{62F Air}

Supplied Air*





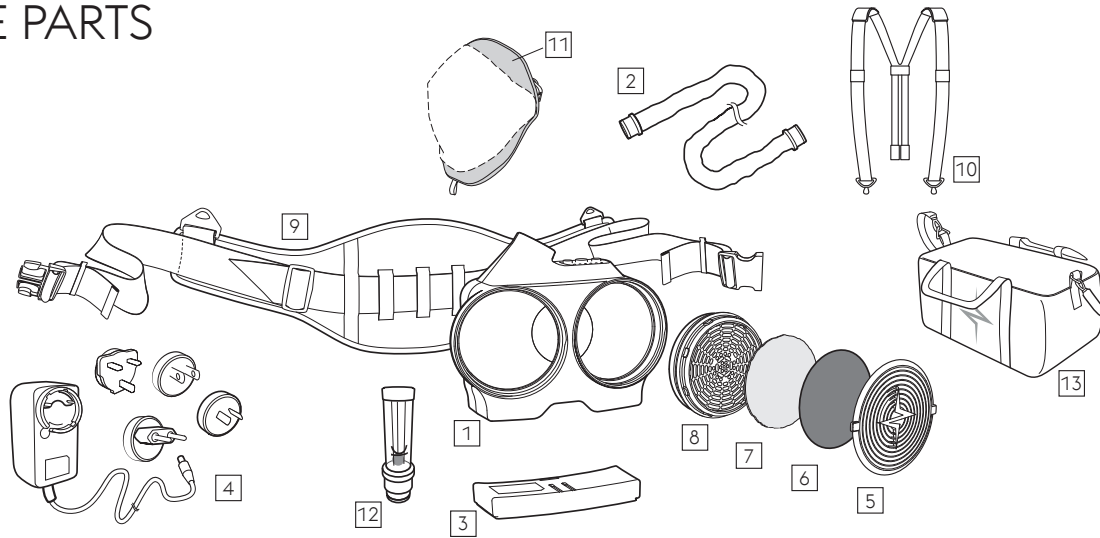

57038

*available in Q3/2022

SPARE PARTS



	Article	
1	 BÖHLER Air motor unit	57044
2	Air hose	
	Standard air hose (100 cm)	64915
	Flexible air hose (90-125 cm)	57065
3	 Heavy-duty battery (7.800 mAh)	57075
4	 Universal charger	57081
5	 Filter cover	
	(2 pieces)	57082
6	 Spark guard	
	(2 pieces)	57089
7	 Pre-filter	
	(20 pieces)	57097
	(40 pieces)	57099
7	 Odour-pre-filter	
	(6 pieces)	75094

	Article	
8	 Particle filter P R SL	
	(4 pieces)	57106
	(16 pieces)	57120
8	 Gas filter A1B1E1 P R SL	
	(2 pieces) - available in Q2/22	57127
9	 Comfort belt	
		57144
	Belt extension (265 mm)	64255
9	 Leather comfort belt	
		75685
10	 Shoulder harness	
		57146
11	 Helmet face-seal	
	for Guardian 62 Air, 62F Air	57182
12	 Airflow tester	
		57184
13	 BÖHLER bag	
		57186

WELDING GLOVES

"Nothing is closer to the welder than the welding gloves. They must be protective on the outside and comfortable on the inside." - Our welding gloves are designed to meet these expectations by selecting high quality leather suppliers, a controlled eco-friendly production process and our striving for a perfect fit.



EUROPEAN LEATHER AND ECO-FRIENDLY PRODUCTION

Only using raw leather from Europe for full control of material and tanning process to achieve high quality products.

HARMLESS TO HEALTH

Materials and products used in and for our Welding Gloves comply with the REACH regulation.

COW & GOAT LEATHER

The right use of split and grain leather from cow and goat combined with perfect shape guarantees products of highest quality.

Regulations:

PPE Regulation (EU) 2016/425 – Category II

Our gloves are marked with a pictogram showing the protection properties according to the standards. All category II gloves are tested, validated and type certified by a notified body.



EN 388

Requirements for protection against mechanical risks, for maintenance work, plant cleaning, work with tools, metal structural work, handling of metal profiles, grinding and/or removal of burr, carpentry, handling of objects with sharp corners and of rough or abrasive objects.

EN 388:2019

abrasion	1-4
resistance to cutting	1-5
resistance to tearing	1-4
resistance to perforation	1-4

1 = lowest level / 4 or 5 = highest level



EN 407

Requirements for protection against heat risks, for occasional contact with small flames and for contact with hot objects at temperatures not exceeding 100 °C.

EN 407:2004

reaction to flame	1-4
contact heat	1-4
convective heat	1-4
radiating heat	1-4
splattering with small quantities of molten metal	1-4

1 = lowest level / 4 = highest level



EN 420

General requirements for most protective gloves:

- » Test methods
- » Design principals and glove assembly
- » Size
- » Maintenance
- » Harmfulness (determination of pH and Chrome VI content)
- » Marking and information to be provided by the manufacturer

GLOVES MODELS



Welding Gloves MIG/MAG

With 1,1-1,3 mm split leather thickness, our MIG/MAG welding gloves provide an excellent protection to the welder.
Category II (according to European Directive (EU) 2016/425), CE-confirm and fulfilling the following standards: EN 388 (4,2,3,4), EN 407 (4,1,3,2,4), EN 420 (Dexterity level 3), EN 12477 (Type A)

Welding Gloves MIG/MAG M/9	61134
Welding Gloves MIG/MAG L/10	53043
Welding Gloves MIG/MAG XL/11	53089



Welding Gloves MIG/MAG Premium

With the combination of goat and cow leather and an optimized shape these MIG/MAG Premium welding gloves provide the perfect fit.
Category II (according to European Directive (EU) 2016/425), CE-Confirm and fulfilling the following standards: EN 388 (2,1,2,2), EN 407 (4,1,3,2,4), EN 420 (Dexterity level 5), EN 12477 (Type A)

Welding Gloves MIG/MAG Premium M/9	61137
Welding Gloves MIG/MAG Premium L/10	53095
Welding Gloves MIG/MAG Premium XL/11	60310



Welding Gloves TIG

These TIG welding gloves are designed for perfect haptic feeling supporting a precise welding work.
Category II (according to European Directive (EU) 2016/425), CE-confirm, fulfilling the following standards: EN 388 (2,1,2,2), EN 407 (4,1,3,2,4), EN 420 (Dexterity level 3), EN 12477 (Type A)

Welding Gloves TIG S/8	61139
Welding Gloves TIG M/9	53026
Welding Gloves TIG L/10	53029



Welding Gloves TIG reinforced

The additional layer of goat leather on the wrist provides better protection against contact heat.
Category II (according to European Directive (EU) 2016/425), CE-confirm, fulfilling the following standards: EN 388 (2,1,2,2), EN 407 (4,1,3,2,4), EN 420 (Dexterity level 3), EN 12477 (Type A)

Welding Gloves TIG reinforced S/8	61158
Welding Gloves TIG reinforced M/9	53033
Welding Gloves TIG reinforced L/10	60309

EYEWEAR

All of our Eyewear models are designed for the use in industrial environments with a variety of glasses certified according to EN 166 F.

Benefits of Eyewear

- » High comfort, long living and protective against UV-light according to DIN EN 170
- » Approved according to CE, EN 166 F
- » Microfiber pouch for storage and cleaning

Eyewear Clear Pro	
Eyewear Clear Pro with	
» large temples and soft pads for better elasticity and comfort	
» hard coating on lenses with anti-fog properties	
» upper shield above the lense to increase protective coverage against falling particles	
Eyewear BÖHLER Clear Pro	52882
Eyewear Classic	
BÖHLER Eyewear Clear	32457
UTP Eyewear Clear	32467
Fontargen Eyewear Clear	32477
for general industrial use	
BÖHLER Eyewear Amber	32458
UTP Eyewear Amber	32468
Fontargen Eyewear Amber	32484
for areas with less light	
BÖHLER Eyewear Blue Mirror	32464
UTP Eyewear Silver Mirror	32469
Fontargen Eyewear Silver Mirror	32486
for outdoor industrial use with sun protection	
BÖHLER Eyewear IR5	32466
UTP Eyewear IR5	32475
Fontargen Eyewear IR5	32496
glasses are classified according to EN 169	





ARC WELDING ACCESSORIES

WELDING TOOLS



EH Snap

Electrode holder in crocodile style with fully insulated handle and lever, spatter resistant tip insulator. Certified according to EN 60974-11 standard

EH Snap 200, 200 Amp (35 %), 5 mm opening	61469
EH Snap 400, 400 Amp (35 %), 6 mm opening	61473
EH Snap 600, 600 Amp (35 %), 8 mm opening	61474



EH Twist

Screw-type electrode holder with fully insulated handle and spatter resistant tip insulator. Certified according to EN 60974-11 standard

EH Twist 200, 200 Amp (35 %), 4 mm opening	61475
EH Twist 400, 400 Amp (35 %), 6 mm opening	61478
EH Twist 600, 600 Amp (35 %), 8 mm opening	61484



Clamp

Earth clamp in crocodile style for easy installation. Span of 50 mm (Clamp 300) and 65 mm (Clamp 400 and Clamp 600) Certified according to EN 60974-11 standard

Clamp 300 with Brass Jaws, 300 Amp (35 %)	61947
Clamp 400 with Brass Jaws, 400 Amp (35 %)	61948
Clamp 600 with Brass Jaws, 600 Amp (35 %)	61949



Chipping Hammer

Both Chipping Hammer types are tempered and have hardened edges. Hammer head with one double beveled and one pointed edge.

Chipping Hammer (small)	61950
Chipping Hammer (curved point)	61951

WELDING CHEMICALS

The most important result for a welder is the perfect weld and the best possible protection of base material and torches.

Anti Spatter Spray

Our non-flammable Anti Spatter Spray is the right choice for your perfect weld! With its unique formula and viscosity it offers an outstanding adhesion on metallic surfaces, it is non-harmful for the welder and biodegradable.

Fields of application:

- » Oxy-fuel cutting
- » Plasma cutting
- » Spot welding
- » MIG-Brazing (CuSi3 / CuAl8)
- » Manual and robotic MIG/MAG torches
- » Hot-tip galvanized and electrogalvanized surfaces
- » Tools, welding jigs and working surfaces

Anti Spatter Spray	
» Water-based, non flammable emulsion	» Ideal viscosity
» Silicone-free	» 360° valve
» Anti-stick effect	» Stable emulsion
Anti Spatter Spray - ES - FR - EN - DE - IT - PT - NL - DA	63647
Anti Spatter Spray - FI - NO - SV - CZ - HU - PL - RO - BG	63660
Anti Spatter Spray - HR - RU - EL - ET - LT - LV - SK - SL	63661



Ceramic Spray

Our Ceramic Spray is high-temperature resistant and offers a long lasting protection for your welding equipment. The use of gas nozzles, contact tips and welding jigs becomes more efficient and economic. It is non-harmful for the welder and biodegradable.

Fields of application:

- » Plasma cutting
- » Manual and robotic MIG/MAG torches
- » Tools and welding jigs

Ceramic Spray	
» Oil free solvent	» Ultra-fast drying ability
» Safe ingredients	» High ceramic content
Ceramic Spray - ES - FR - EN - DE - IT - PT - NL - DA	63663
Ceramic Spray - FI - NO - SV - CZ - HU - PL - RO - BG	63667



WELDING BLANKETS

Welding Blankets are a piece of safety equipment designed to protect you, your equipment, our environment and other valuable items. However, they do not only provide protection from spatters, sparks, heat radiation, particle impacts and molten metals, they also insulate rays to establish a safe and clean work environment.

General features:

- » No differentiation between sides - Front and back are equal in their properties
- » Anti-oxidation - No chemical reaction is triggered when sparks hit the welding blanket
- » All blankets are offering protection against spatters, sparks & slag

Recommendation for use:

All blankets are to be used on an incline of at least 15 degrees.

Sparks hitting a blanket, which is positioned horizontally, will put extra stress on the material. In such a case a stronger and more heat resistant blanket should be used.

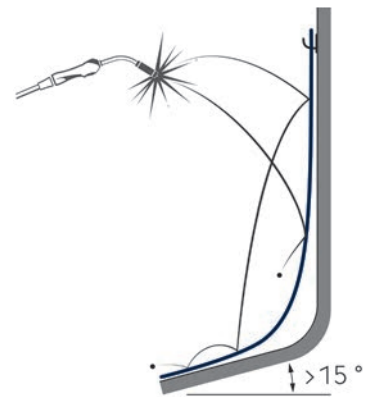

	WB Fibre 550	WB Fibre Plus 750	WB Silica 1100	WB Light 1250
				
Basic material	Fibreglass	Fibreglass	Uncoated Silica - 2% PU	O-PAN
Material structure	woven, plain	woven, plain	woven, 8HS Satin	felt
Coating/ treatment	-	Vermiculite	-	-
Mass	580 g/m ²	875 g/m ²	600 g/m ²	420 g/m ²
Thickness	0.75 mm	1.06 mm	0.70 mm	3.6 - 4.0 mm
Working temperature	550 °C	750 °C	1100 °C	250 °C
Melting point	750 °C	950 °C	1350 °C	(1250 °C - instand impact)
Colour	tan	black	tan	black

WELDING BLANKET TYPES:

WB Fibre 550		
Technical specification	Features	Application
<ul style="list-style-type: none"> » Uncoated fibreglass » Working temp.: 550 °C » Melting point: 750 °C » Weight: 580 g/m² 	<ul style="list-style-type: none"> » Temperature resistance » Eyelets on all four sides 	<ul style="list-style-type: none"> » Light welding & cutting



WB Fibre Plus 750		
Technical specification	Features	Application
<ul style="list-style-type: none"> » Vermiculite* coated fibreglass » Working temp.: 750 °C » Melting point: 950 °C » Weight: 875 g/m² 	<ul style="list-style-type: none"> » Higher abrasion resistance » Fireproof » Higher temperature resistance » Eyelets on all four sides 	<ul style="list-style-type: none"> » Medium welding & cutting processes



* Vermiculite is a (hydrated phyllosilicate) mineral

WB Silica 1100		
Technical specification	Features	Application
<ul style="list-style-type: none"> » Uncoated silica* with 2% PU » Working temp.: 1100 °C » Melting point: 1350 °C » Weight: 600 g/m² 	<ul style="list-style-type: none"> » Acid resistance » Eyelets on all four sides 	<ul style="list-style-type: none"> » Heavy duty welding & cutting processes



* Silica = Silicon dioxide (e.g. quartz - one of the most commonly found minerals in nature)

WB Light 1250		
Technical specification	Features	Application
<ul style="list-style-type: none"> » 100% O-Pan* non-woven » Working temp.: 250 °C » Weight: 420 g/m² 	<ul style="list-style-type: none"> » Excellent thermal insulation » Impact protection against particles » Fibreglass free – smooth touch, no scratching » Light and portable » Can be easily cut 	<ul style="list-style-type: none"> » Sand blasting & heat treatment » Light welding & cutting processes » Complicated & narrow applications » Ideal for sensitive surfaces » Instant impact up to 1250°C**

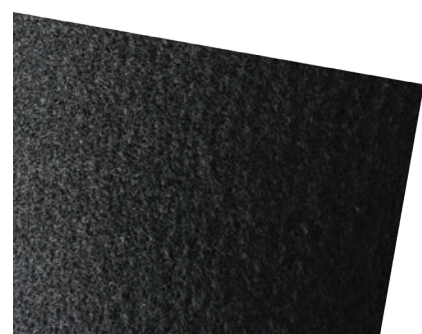

* Oxidized-Polyacrylonitrile (felt-like synthetic material) which evaporates and dissolves itself when exposed permanently to high temperatures. It does not melt. | ** NOT TO BE USED AS EMERGENCY BLANKET!

Product availability:

WB Fibre 550		WB Fibre Plus 750		WB Silica 1100		WB Light 1250	
Sizes	Art. No.	Sizes	Art. No.	Sizes	Art. No.	Sizes	Art. No.
1x1 m	72497	1x1 m	72655	0.92x1 m	72690	1x1 m	72730
1x2 m	72622	1x2 m	72662	0.92x2 m	72693	1x2 m	72752
2x2 m	72635	2x2 m	72677	1.80x2 m	72694	2x2 m	72754
2x3 m	72642	2x3 m	72678	1.80x3 m	72712	2x3 m	72759
1x25 m*	72650	1x25 m*	72681	0.92x25 m*	72723	1x25 m*	72760

* Rolled welding blankets are without eyelets and can be tailored to your own needs.

JOIN! voestalpine Böhler Welding

We are a leader in the welding industry with over 100 years of experience, more than 50 subsidiaries and more than 4,000 distribution partners around the world. Our extensive product portfolio and welding expertise combined with our global presence guarantees we are close when you need us. Having a profound understanding of your needs enables us to solve your demanding challenges with Full Welding Solutions - perfectly synchronized and as unique as your company.



Lasting Connections – Perfect alignment of welding machines, consumables and technologies combined with our renowned application and process know-how provide the best solution for your requirements: A true and proven connection between people, products and technologies. The result is what we promise: Full Welding Solutions for Lasting Connections.



Tailor-Made Protectivity™ – The combination of our high-quality products and application expertise enables you to not only repair and protect metal surfaces and components. Our team of engineers, experienced in your specific applications, offer you customized solutions resulting in increased productivity for your demanding challenge. The result is what we promise: Tailor-Made Protectivity™.



In-Depth Know-How – As a manufacturer of soldering and brazing consumables, we offer proven solutions based on 60 years of industrial experience, tested processes and methods, made in Germany. This in-depth know-how makes us the internationally preferred partner to solve your soldering and brazing challenge through innovative solutions. The result is what we promise: Innovation based on in-depth know-how.

The Management System of voestalpine Böhler Welding Group GmbH, Peter-Mueller-Strasse 14-14a, 40469 Duesseldorf, Germany has been approved by Lloyd's Register Quality Assurance to: ISO 9001:2015, ISO 14001:2015, OHSAS 18001:2007, applicable to: Development, Manufacturing and Supply of Welding and Brazing Consumables. More information: www.voestalpine.com/welding



