

# Uddeholm Dievar<sup>®</sup>

Also available for additive manufacturing

## Uddeholm Dievar® – The new generation

The new generation of Uddeholm Dievar provides outstanding performance. The unique problem-solving chemistry, combined with the latest re-melting technology and new process improvements over the whole manufacturing route has resulted in a new level of very high toughness and ductility. The new generation of Uddeholm Dievar gives you the best of both worlds in its class:

- The classic chemistry of Dievar to fight heat checking or thermal fatigue
- The new class-leading toughness to use in bigger die inserts

The steel is suitable in high demand hot work applications like die casting, forging and extrusion. The property profile makes it also suitable in other applications, e.g. plastics and High Performance Steel.

Uddeholm Dievar offers the potential for significant improvements in die life, thereby improving the tooling economy.

© UDDEHOLMS AB

No part of this publication may be reproduced or transmitted for commercial purposes without permission of the copyright holder.

---

This information is based on our present state of knowledge and is intended to provide general notes on our products and their uses. It should not therefore be construed as a warranty of specific properties of the products described or a warranty for fitness for a particular purpose.

Classified according to EU Directive 1999/45/EC  
For further information see our "Material Safety Data Sheets".

Edition 14, 03.2022



## GENERAL

Uddeholm Dievar is a high performance chromium-molybdenum-vanadium alloyed hot work tool steel which offers very good resistance to heat checking, gross cracking, hot wear and plastic deformation. It is tested and approved according to the NADCA specification before delivery. Uddeholm Dievar is characterized by:

- Excellent ductility in all directions
- Excellent cleanliness
- A new level of toughness  $\geq 25$  J
- Very good temper resistance
- Very good high-temperature strength
- Excellent hardenability
- Suitable for nitriding
- Good dimensional stability throughout heat treatment and coating operations

Typical analysis %	C	Si	Mn	Cr	Mo	V
	0.35	0.2	0.5	5.0	2.3	0.6
Standard specification	None					
Delivery condition	Soft annealed to approx. 160 HB					
Colour code	Yellow/grey					

## IMPROVED TOOLING PERFORMANCE

Uddeholm Dievar is a premium hot work tool steel developed by Uddeholm. Uddeholm Dievar is like all Uddeholm grades, exposed to a continuous improvement of the processes throughout the whole of production. Improved processes in the melting shop followed by the latest re-melting technology have given a further increased level of homogeneity and cleanliness. In addition to this, changes and improvements have been made in the heat-treatment and hot-working processes which resulted in a hot-work tool steel that is able to reach a new level of toughness.

Today, Uddeholm Dievar is delivered with a tested toughness of  $\geq 25$  J according to the NADCA standard. This combination, with its unique chemical composition, gives the die steel ultimate resistance to heat checking, gross cracking, hot wear and plastic deformation. The unique properties profile for Uddeholm Dievar makes it the best choice for die casting, forging and extrusion.

## HOT WORK APPLICATIONS

Heat checking is one of the most common failure mechanisms e.g. in die casting and nowadays also in forging applications. Uddeholm Dievar's superior properties yield the highest possible level of heat checking resistance. It is a known fact that a higher hardness level improves the heat-checking resistance. By taking advantage of Uddeholm Dievar's outstanding toughness and hardenability, the resistance to heat checking can be further improved by increasing the hardness level with up to 2 HRC (if gross cracking is not a factor). Regardless of the dominant failure mechanism (heat checking, gross cracking, hot wear or plastic deformation) Uddeholm Dievar offers the potential for significant improvements in die life, and resulting in better tooling economy.

Uddeholm Dievar is the material of choice for the high demand die casting-, forging- and extrusion industries.

### DIEVAR VS H13 - HEAT CHECKING RESISTANCE

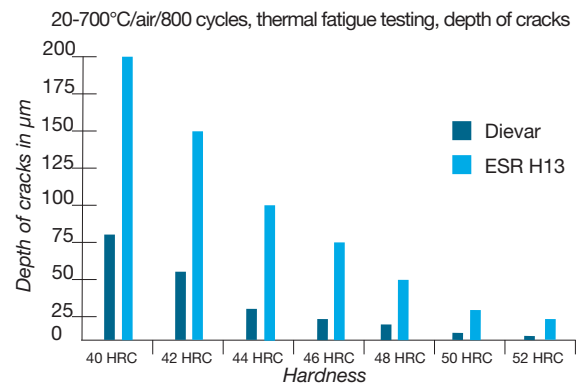

## UDDEHOLM DIEVAR IN LARGER SIZES

Changes in the automotive industry have pushed demand for larger and more complex parts. Structural parts, battery boxes and electrical motor housings have implied demand for very large die inserts and in some cases, whole dies.

Uddeholm Dievar can be made into these blocks using standard upset forged ingots.

For sizes outside the standard ingot range, contact your local sales team to see if your non-standard size can conform to Dievar - 25 Joules quality standards. In the below chart we can see 2 examples of non-standard sizes which exceeded 25 Joules.

Examples of sizes outside of the standard range

Size mm	Charpy-V [J]	Grain size	Micro-structure
1300 x 600	28	7	B3
1550 x 550	26	7	B3

Acc. To the NADCA standard

**TOOLS FOR DIE CASTING**

Part	Aluminium, magnesium alloys
Dies	44-50 HRC

**TOOLS FOR EXTRUSION**

Copper, Part	Aluminium, copper alloys HRC	magnesium alloys HRC
Dies	-	46-52
Liners, dummy blocks, stems	46-52	44-52

**TOOLS FOR HOT FORGING**

Part	Steel, Aluminium
Inserts	44-52 HRC

**PROPERTIES**

The reported properties are representative of samples which have been taken from the centre of a 610 x 203 mm (24" x 8") bar. Unless otherwise is indicated all specimens have been hardened at 1025°C (1875°F), quenched in oil and tempered twice at 615°C (1140°F) for two hours; yielding a working hardness of 44-46 HRC.

**PHYSICAL PROPERTIES**

DATA AT ROOM AND ELEVATED TEMPERATURES

Temperature (68°F)	20°C (75°F)	400°C (1110°F)	600°C
Density, kg/m <sup>3</sup> lbs/in <sup>3</sup>	7 800 0.281	7 700 0.277	7 600 0.274
Modulus of elasticity MPa psi	210 000 30.5 x 10 <sup>6</sup>	180 000 26.1 x 10 <sup>6</sup>	145 000 21.0 x 10 <sup>6</sup>
Coefficient of thermal expansion per °C from 20°C per °F from 68°F	-	12.7 x 10 <sup>-6</sup> 7.0 x 10 <sup>-6</sup>	13.3 x 10 <sup>-6</sup> 7.3 x 10 <sup>-6</sup>
Thermal conductivity W/m °C Btu in/(ft <sup>2</sup> h°F)	-	31 216	32 223

**MECHANICAL PROPERTIES**

TENSILE PROPERTIES AT ROOM TEMPERATURE, SHORT TRANSVERSE DIRECTION

Hardness	44 HRC	48 HRC	52 HRC
Tensile strength R <sub>m</sub>	1480 MPa 96 tsi 214 000 psi	1640 MPa 106 tsi 237 000 psi	1900 MPa 123 tsi 275 000 psi
Yield strength R <sub>p0,2</sub>	1210 MPa 8 tsi 175 000 ps	1380 MPa 89 tsi 200 000 psi	1560 MPa 101 tsi 226 000 psi
Elongation A <sub>5</sub>	13 %	13 %	12,5 %
Reduction of area Z	55 %	55 %	52 %

**TENSILE PROPERTIES AT ELEVATED TEMPERATURE**

SHORT TRANSVERSE DIRECTION

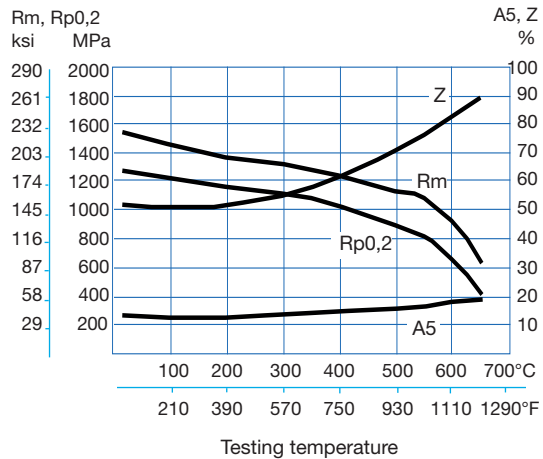

Minimum average unnotched impact ductility is 300 J (220 ft lbs) in the short transverse direction at 44-46 HRC.

**CHARPY V-NOTCH IMPACT TOUGHNESS AT ELEVATED TEMPERATURE SHORT TRANSVERSE DIRECTION**

Impact energy

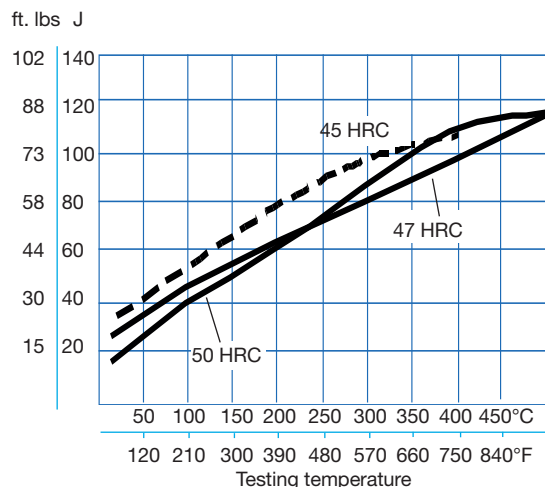

### TEMPER RESISTANCE

The specimens have been hardened and tempered to 45 HRC and then held at different temperatures from 1 to 100 hours.

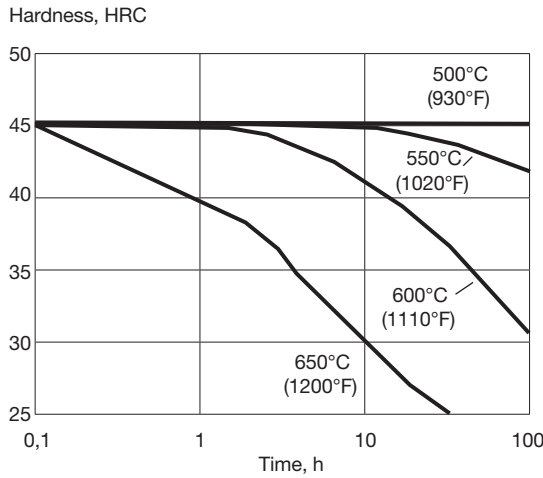

## HEAT TREATMENT – GENERAL RECOMMENDATIONS

### SOFT ANNEALING

Protect the steel and heat through to 850°C (1560°F). Then cool in furnace at 10°C (20°F) per hour to 600°C (1110°F), then freely in air.

### STRESS RELIEVING

After rough machining the tool should be heated through to 650°C (1200°F), holding time 2 hours. Cool slowly to 500°C (930°F), then freely in air.

### HARDENING

**Preheating temperature:** 600–900°C (1110–1650°F). Normally a minimum of two preheats, the first in the 600–650°C (1110–1200°F) range, and the second in the 820–850°C (1510–1560°F) range. When three preheats are used the second is carried out at 820°C (1510°F) and the third at 900°C (1650°F).

**Austenitizing temperature:** 1000–1025°C (1830–1880°F). General guideline for larger dies with thickness >250 mm then max austenitizing temperature 1010°C (1850°F) is recommended.

Temperature °C	Temperature °F	Soaking time* minutes	Hardness before tempering
1000	1830	30	52 ±2 HRC
1025	1875	30	55 ±2 HRC

\* Soaking time = time at hardening temperature after the tool is fully heated through

*Protect the tool against decarburization and oxidation during austenitizing.*

### CCT GRAPH

Austenitizing temperature 1025°C (1877°F). Holding time 30 minutes.

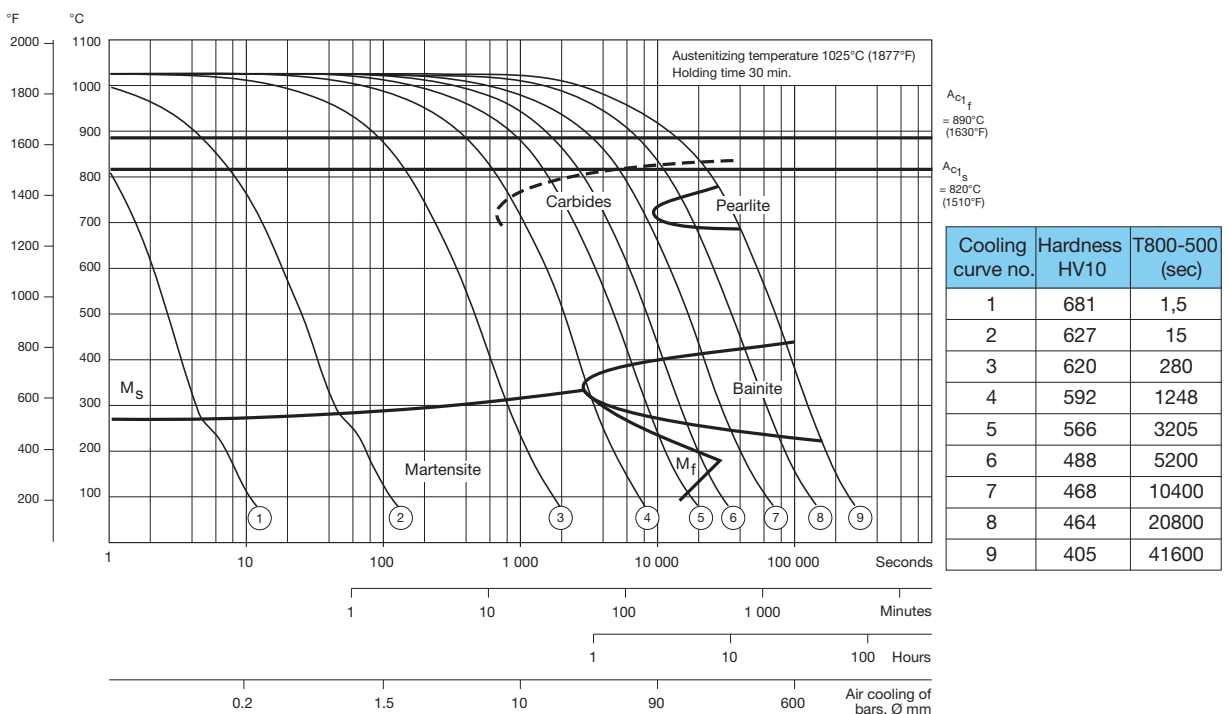

**CCT GRAPH**

Austenitizing temperature 1010°C (1850°F). Holding time 30 minutes.

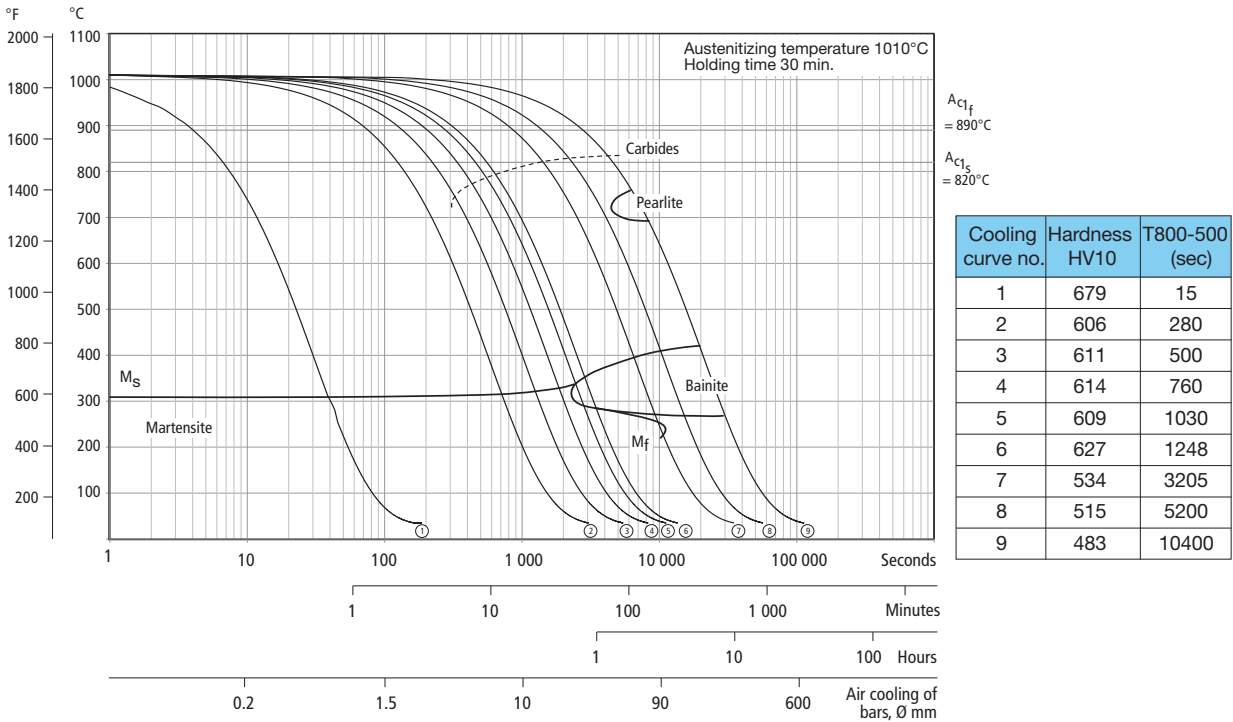

**HARDNESS, GRAIN SIZE AND RETAINED AUSTENITE AS FUNCTIONS OF AUSTENITIZING TEMPERATURE**

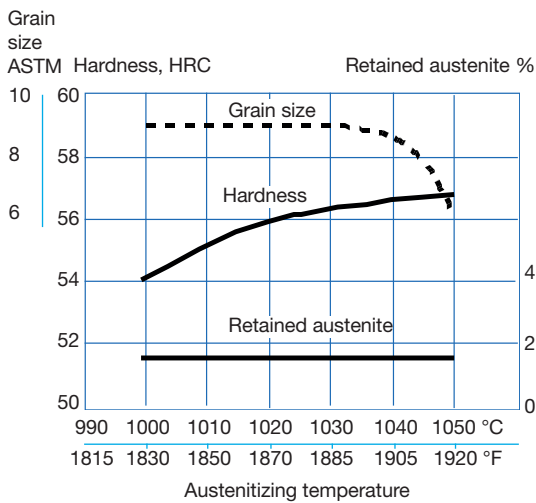

**QUENCHING**

As a general rule, quench rates should be as rapid as possible. Accelerated quench rates are required to optimize tool properties specifically with regards to toughness and resistance to gross cracking. However, risk of excessive distortion and cracking must be considered.

**QUENCHING MEDIA**

The quenching media should be capable of creating a fully hardened microstructure. Different quench rates for Uddeholm Dievar are defined by the CCT graph, page 5 and 6.

**RECOMMENDED QUENCHING MEDIA**

- High speed gas/circulating atmosphere
- Vacuum (high speed gas with sufficient positive pressure). An interrupted quench at 425–450°C (800–840°F) is recommended where distortion control and quench cracking are a concern
- Martempering bath, salt bath or fluidized bed at 450–550°C (840–1020°F)
- Martempering bath, salt bath or fluidized bed at 180–200°C (360–390°F)
- Warm oil, approx. 80°C (180°F)

*Note:* Temper the tool as soon as its temperature reaches 50–70°C (120–160°F).

**TEMPERING**

Choose the tempering temperature according to the hardness required by reference to the tempering graph below. Temper minimum three times for die casting dies and minimum twice for forging and extrusion tools with intermediate cooling to room temperature. Holding time at temperature minimum 2 hours.

Tempering in the range of 500–550°C (930–1020°F) for the intended final hardness will result in a lower toughness.

**TEMPERING GRAPH**

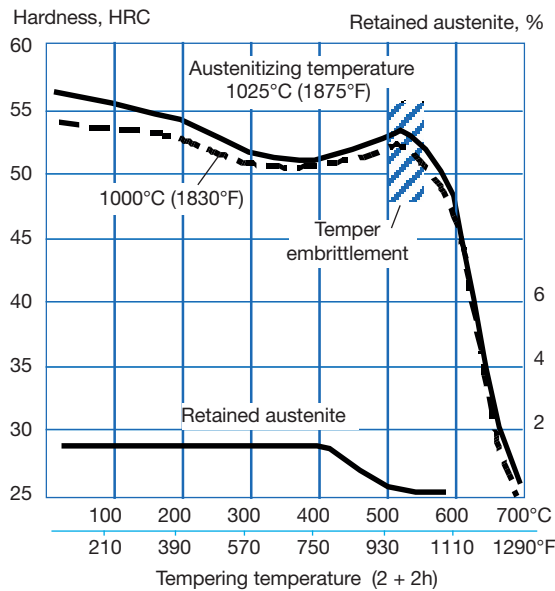

Above tempering curves are obtained after heat treatment of samples with a size of 15 x 15 x 40 mm, cooling in forced air. Lower hardness can be expected after heat treatment of tools and dies due to factors like actual tool size and heat treatment parameters.

**EFFECT OF TEMPERING TEMPERATURE ON ROOM TEMPERATURE CHARPY V NOTCH IMPACT ENERGY**

Short transverse direction.

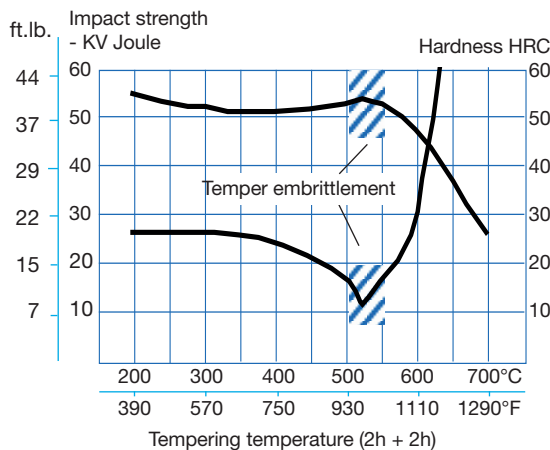

**DIMENSIONAL CHANGES DURING HARDENING AND TEMPERING**

During hardening and tempering the tool is exposed to both thermal and transformation stresses. These stresses will result in distortion. Insufficient levels of machine stock may result in slower than recommended quench rates during heat treatment. In order to predict maximum levels of distortion with a proper quench, a stress relief is always

recommended between rough and semi-finish machining, prior to hardening. For a stress relieved Uddeholm Dievar tool a minimum machine stock of 0.3% is recommended to account for acceptable levels of distortion during a heat treatment with a rapid quench.

**NITRIDING AND NITROCARBURIZING**

Nitriding and nitrocarburizing result in a hard surface layer which has the potential to improve resistance to wear and soldering, as well as resistance to premature heat checking. Uddeholm Dievar can be nitrided and nitrocarburized via a plasma, gas, fluidized bed, or salt process. The temperature for the deposition process should be minimum 25–50°C (50–90°F) below the highest previous tempering temperature, depending upon the process time and temperature. Otherwise a permanent loss of core hardness, strength, and/or dimensional tolerances may be experienced.

During nitriding and nitrocarburizing, a brittle compound layer, known as the white layer, may be generated. The white layer is very brittle and may result in cracking or spalling when exposed to heavy mechanical or thermal loads. As a general rule the white layer formation must be avoided. Nitriding in ammonia gas at 510°C (950°F) or plasma nitriding at 480°C (895°F) both result in a surface hardness of approx. 1100 HV<sub>0.2</sub>. In general, plasma nitriding is the preferred method because of better control over nitrogen potential. However, careful gas nitriding can give same results.

The surface hardness after nitrocarburizing in either gas or salt bath at 580°C (1075°F) is approx. 1100 HV<sub>0.2</sub>.

**DEPTH OF NITRIDING**

Process	Time	Hardness Depth*	HV <sub>0.2</sub>
Gas nitriding at 510°C (950°F)	10 h	0.16 mm 0.0063 inch	1100
	30 h	0.22 mm 0.0087 inch	1100
Plasma nitriding at 480°C (895°F)	10 h	0.15 mm 0.0059 inch	1100
Nitrocarburizing – in gas at 580°C (1075°F) – in salt bath at 580°C (1075°F)	2 h	0.13 mm 0.0051 inch	1100
	1 h	0.08 mm 0.0031 inch	1100

\* Depth of case = distance from surface where hardness is 50 HV<sub>0.2</sub> over base hardness



## CUTTING DATA RECOMMENDATIONS

The cutting data below are to be considered as guiding values which must be adapted to existing local condition.

The recommendations, in following tables, are valid for Uddeholm Dievar in soft annealed condition approx. 160 HB.

### TURNING

Turning with Cutting data parameters	Turning carbide		with high speed steel Fine turning
	Rough turning	Fine turning	
Cutting speed ( $v_c$ ) m/min f.p.m.	150–200 490–655	200–250 655–820	15–20 50–65
Feed (f) mm/r i.p.r.	0.2–0.4 0.008–0.016	0.05–0.2 0.002–0.008	0.05–0.3 0.002–0.012
Depth of cut ( $a_p$ ) mm inch	2–4 0.08–0.16	0.5–2 0.02–0.08	0.5–2 0.02–0.08
Carbide designation ISO US	P20–P30 C6–C5 Coated carbide	P10 C7 Coated carbide or cermet	– –

### MILLING

#### FACE- AND SQUARE SHOULDER MILLING

Cutting data parameters	Milling with carbide	
	Rough milling	Fine milling
Cutting speed ( $v_c$ ) m/min f.p.m.	130–180 430–590	180–220 590–720
Feed ( $f_z$ ) mm/tooth inch/tooth	0.2–0.4 0.008–0.016	0.1–0.2 0.004–0.008
Depth of cut ( $a_p$ ) mm inch	2–4 0.08–0.16	–2 –0.08
Carbide designation ISO US	P20–P40 C6–C5 Coated carbide	P10 C7 Coated carbide or cermet

### END MILLING

Cutting data parameters	Type of milling		
	Solid carbide	Carbide indexable insert	High speed steel
Cutting speed ( $v_c$ ) m/min f.p.m.	130–170 425–560	120–160 390–520	25–30 <sup>1)</sup> 80–100 <sup>1)</sup>
Feed ( $f_z$ ) mm/tooth inch/tooth	0.03–0.20 <sup>2)</sup> 0.001–0.008 <sup>2)</sup>	0.08–0.20 <sup>2)</sup> 0.003–0.008 <sup>2)</sup>	0.05–0.35 <sup>2)</sup> 0.002–0.014 <sup>2)</sup>
Carbide designation ISO US	–	P20–P30 C6–C5	– –

<sup>1)</sup> For coated HSS end mill  $v_c = 45–50$  m/min. (150–160 f.p.m.)

<sup>2)</sup> Depending on radial depth of cut and cutter diameter

### DRILLING

#### HIGH SPEED STEEL TWIST DRILL

Drill diameter		Cutting speed ( $v_c$ )		Feed (f)	
mm	inch	m/min	f.p.m.	mm/r	i.p.r.
– 5	–3/16	15–20*	49–66*	0.05–0.15	0.002–0.006
5–10	3/16–3/8	15–20*	49–66*	0.15–0.20	0.006–0.008
10–15	3/8–5/8	15–20*	49–66*	0.20–0.25	0.008–0.010
15–20	5/8–3/4	15–20*	49–66*	0.25–0.35	0.010–0.014

\* For coated HSS drill  $v_c = 35–40$  m/min. (110–130 f.p.m.)

#### CARBIDE DRILL

Cutting data parameters	Type of drill		
	Indexable insert	Solid carbide	Carbide tip <sup>1)</sup>
Cutting speed ( $v_c$ ) m/min f.p.m.	180–220 590–720	120–150 390–490	60–90 195–295
Feed (f) mm/r i.p.r.	0.05–0.25 <sup>2)</sup> 0.002–0.01 <sup>2)</sup>	0.10–0.25 <sup>3)</sup> 0.004–0.01 <sup>3)</sup>	0.15–0.25 <sup>4)</sup> 0.006–0.01 <sup>4)</sup>

<sup>1)</sup> Drill with replaceable or brazed carbide tip

<sup>2)</sup> Feed rate for drill diameter 20–40 mm (0.8”–1.6”)

<sup>3)</sup> Feed rate for drill diameter 5–20 mm (0.2”–0.8”)

<sup>4)</sup> Feed rate for drill diameter 10–20 mm (0.4”–0.8”)

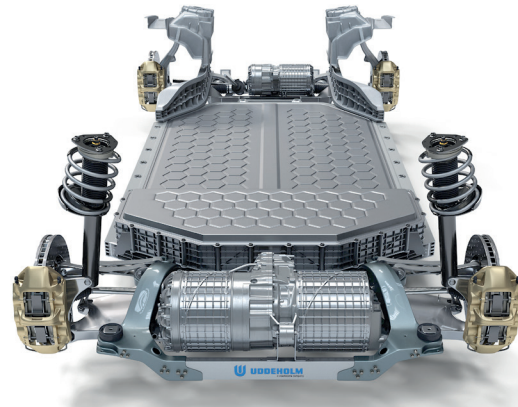

E-mobility – picture showing e.g. battery box, electrical motor housing and structural parts on an EV car.



## CUTTING DATA RECOMMENDATIONS

The cutting data below should be considered as guidelines only. These guidelines must be adapted to local machining conditions.

The recommendations, in following tables, are valid for Uddeholm Dievar hardened and tempered to 44–46 HRC.

### TURNING

Cutting data parameters	Turning with carbide	
	Rough turning	Fine turning
Cutting speed ( $v_c$ ) m/min f.p.m.	40–60 130–195	70–90 230–295
Feed (f) mm/r i.p.r.	0.2–0.4 0.008–0.016	0.05–0.2 0.002–0.008
Depth of cut ( $a_p$ ) mm inch	1–2 0.04–0.08	0.5–1 0.02–0.04
Carbide designation ISO US	P20–P30 C6–C5 Coated carbide	P10 C7 Coated carbide or mixed ceramic

### DRILLING

#### HIGH SPEED STEEL TWIST DRILL (TICN COATED)

Drill diameter		Cutting speed ( $v_c$ )		Feed (f)	
mm	inch	m/min	f.p.m.	mm/r	i.p.r.
– 5	–3/16	4–6	13–20	0.05–0.10	0.002–0.004
5–10	3/16–3/8	4–6	13–20	0.10–0.15	0.004–0.006
10–15	3/8–5/8	4–6	13–20	0.15–0.20	0.006–0.008
15–20	5/8–3/4	4–6	13–20	0.20–0.30	0.008–0.012

#### CARBIDE DRILL

Cutting data parameters	Type of drill		
	Indexable insert	Solid carbide	Carbide tip <sup>1)</sup>
Cutting speed ( $v_c$ ) m/min f.p.m.	60–80 195–260	60–80 195–260	40–50 130–160
Feed (f) mm/r i.p.r.	0.05–0.25 <sup>2)</sup> 0.002–0.01 <sup>2)</sup>	0.10–0.25 <sup>3)</sup> 0.004–0.01 <sup>3)</sup>	0.15–0.25 <sup>4)</sup> 0.006–0.01 <sup>4)</sup>

<sup>1)</sup> Drill with replaceable or brazed carbide tip

<sup>2)</sup> Feed rate for drill diameter 20–40 mm (0.8”–1.6”)

<sup>3)</sup> Feed rate for drill diameter 5–20 mm (0.2”–0.8”)

<sup>4)</sup> Feed rate for drill diameter 10–20 mm (0.4”–0.8”)

### MILLING

#### FACE- AND SQUARE SHOULDER MILLING

Cutting data parameters	Milling with carbide	
	Rough milling	Fine milling
Cutting speed ( $v_c$ ) m/min f.p.m.	50–90 160–295	90–130 295–425
Feed ( $f_z$ ) mm/tooth inch/tooth	0.2–0.4 0.008–0.016	0.1–0.2 0.004–0.008
Depth of cut ( $a_p$ ) mm inch	2–4 0.08–0.16	–2 –0.08
Carbide designation ISO US	P20–P40 C6–C5 Coated carbide	P10 C7 Coated carbide or cermet

### END MILLING

Cutting data parameters	Type of milling		
	Solid carbide	Carbide indexable insert	High speed steel TICN coated
Cutting speed ( $v_c$ ) m/min f.p.m.	60–80 195–260	70–90 230–295	5–10 16–33
Feed ( $f_z$ ) mm/tooth inch/tooth	0.03–0.20 <sup>1)</sup> 0.001–0.00 <sup>1)</sup>	0.08–0.20 <sup>1)</sup> 0.003–0.008 <sup>1)</sup>	0.05–0.35 <sup>1)</sup> 0.002–0.014 <sup>1)</sup>
Carbide designation ISO US	–	P10–P20 C6–C5	– –

<sup>1)</sup> Depending on radial depth of cut and cutter diameter

### GRINDING

A general grinding wheel recommendation is given below. More information can be found in the Uddeholm publication “Grinding of Tool Steel”.

#### WHEEL RECOMMENDATION

Type of grinding	Soft annealed condition	Hardened condition
Face grinding straight wheel	A 46 HV	A 46 HV
Face grinding segments	A 24 GV	A 36 GV
Cylindrical grinding	A 46 LV	A 60 KV
Internal grinding	A 46 JV	A 60 IV
Profile grinding	A 100 LV	A 120 JV

## ADDITIVE MANUFACTURING

Uddeholm Dievar is also available for additive manufacturing, powder for processing Laser Powder Bed Fusion (LPBF) and Laser Metal Deposition (LMD). This powder is a gas atomized Uddeholm Dievar product with physical and mechanical properties within the normal variation as the ESR material.

## GENERAL

Uddeholm Dievar for additive manufacturing offers several advantages in the field of additive manufacturing.

- Superior Toughness level in hardened and tempered condition
- High temper resistance
- High temperature strength
- Very high applicability for hybrids when chromium martensitic tool steel are used as base geometry

## APPLICATION

- HPDC inserts
- Hot Stamping Dies
- Plastic moulds
- Engineering parts

## POWDER CHARACTERISTICS

The chemical composition is the same as the ESR material for the core elements and a maximum Oxygen level of 200 ppm on the powder.

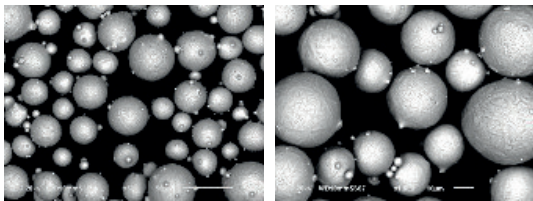

## SHAPE DISTRIBUTION AND DENSITY

Typical values

Sphericity	0,93
Aspect ratio	0,90
Apparent density kg/m <sup>3</sup>	3900
Tap density kg/m <sup>3</sup>	4700
True density kg/m <sup>3</sup>	7800

## PARTICLE SIZE AND DISTRIBUTION

Uddeholm Dievar for additive manufacturing has a sieved particle size that is between 20-50 µm.

Typical values

D10	D50	D90
24 µm	36 µm	49 µm

## PROPERTIES

### IMPACT TOUGHNESS

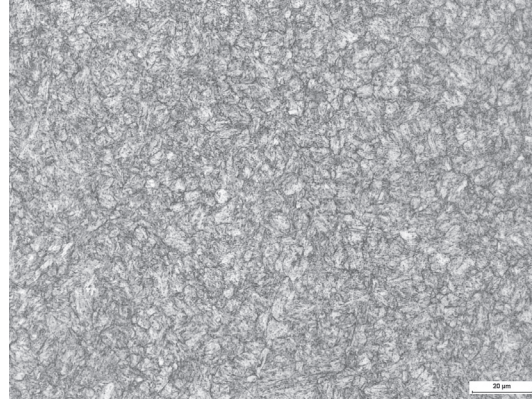

Microstructure in hardened tempered condition, magnification 500x.

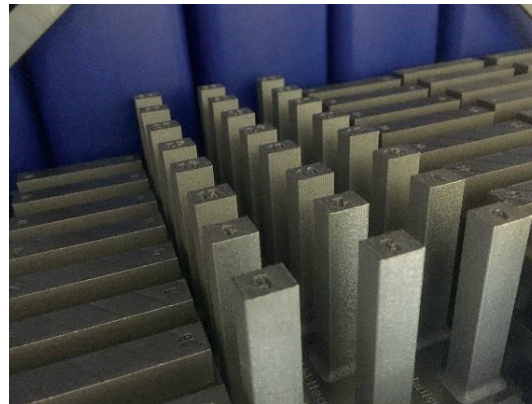

Uddeholm Dievar for additive manufacturing vs 1.2709 and AM H13, printed vertical direction and heat treated to hardness range of 46-48 HRC. The fine grain structure of Uddeholm Dievar for additive manufacturing results in superior high toughness values.

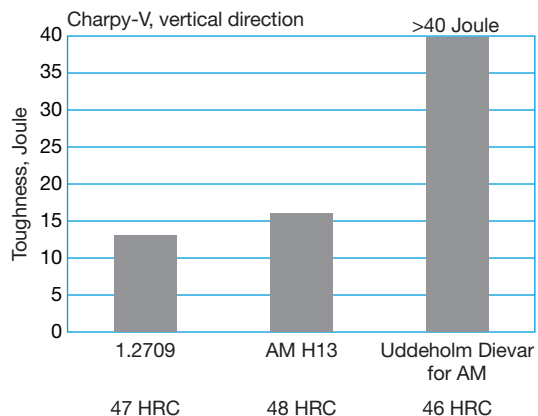

### SOLDERING

Soldering test, mass loss of agitated soldering test. Mass loss in gram showed in y-axes after 2 hours rotating with 200 rpm in aluminum A380 melt. Lower mass loss indicates a higher soldering resistance. Result shows a higher soldering resistance for Uddeholm Dievar for additive manufacturing.

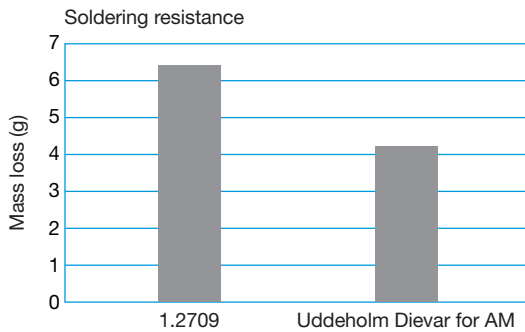

### TEMPER RESISTANCE

Temper-back resistance curve (44-46 HRC) at 600 °C

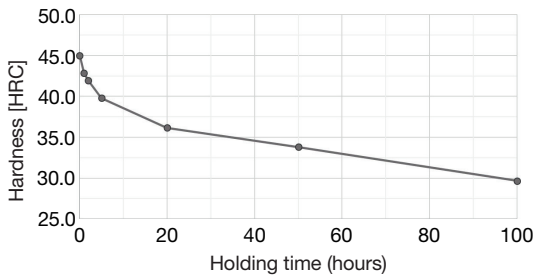

### AM PROCESSING

Machine	EOS M290	
Layer thickness	30 µm	60 µm
Laser Power	267.7 W	331 W
Scan speed	907.7 mm/s	908.8 mm/s
Hatch distance	0.1153 mm	0.1019 mm
Hatch mode	Stripes, 9.75 mm	Stripes, 9.75 mm
Build plate temperature	160 °C	200 °C

Use base plate and hybrid material of similar thermal properties e.g. Uddeholm Dievar.

### POST PROCESS

#### PRE-HEATING BEFORE HARDENING

After printing, the built part will contain a various amount of residual stresses. To lower the harm of these stresses and avoid extra thermal stresses pre-heating is recommended before hardening.

Heating rate of 7 °C/minutes, pre-heating steps:

650 °C/10 minutes

850 °C/10 minutes

#### HARDENING

Hardening should be carried out with the same recommendation as for Uddeholm Dievar for additive manufacturing.

#### TEMPERING

Note that hardness in Dievar base geometry will be ~2 HRC harder if hybrids is used.

Tempering temperature/time	Hardness
605 °C/2x2 hours	44-46 HRC
600 °C/2x2 hours	46-48 HRC
590 °C/2x2 hours	48-50 HRC

### LMD

Uddeholm Dievar for additive manufacturing can be used in Laser Metal Deposition and is therefore available in the size fraction 50-150 µm. Possible to reach a hardness level of 52-54 HRC. Recommended post process treatment after cladding is tempering 25 °C below the prior tempering temperature.

## WELDING

Welding of die components can be performed, with acceptable results, as long as the proper precautions are taken during the preparation of the joint, the filler material selection, the preheating of the die, the controlled cooling of the die and the post weld heat treatment processes. The following guidelines summarize the most important welding process parameters.

For more detailed information refer to the Uddeholm brochure “Welding of Tool Steel”.

Welding method	TIG	MMA
Preheating temperature*	325–375°C (620–710°F)	325–375°C (620–710°F)
Filler metals	DIEVAR TIG-Weld QRO 90 TIG-Weld	QRO 90 Weld
Maximum interpass temperature	475°C (880°F)	475°C (880°F)
Post welding cooling	20–40°C/h (35–70°F/h) for the first 2–3 hours and then freely in air.	
Hardness after welding	48–53 HRC	48–53 HRC
<i>Heat treatment after welding</i>		
Hardened condition	Temper 10–20°C (20–40°F) below the highest previous tempering temperature.	
Soft annealed condition	Soft-anneal the material at 850°C (1560°F) in protected atmosphere. Then cool in the furnace at 10°C (20°F) per hour to 600°C (1110°F) then freely in air.	

\* Preheating temperature must be established throughout the die and must be maintained for the entirety of the welding process, to prevent weld cracking.

## ELECTRICAL DISCHARGE MACHINING – EDM

Following the EDM process, the applicable die surfaces are covered with a resolidified layer (white layer) and a rehardened and untempered layer, both of which are very brittle and hence detrimental to die performance. If EDM is used the white layer must be completely removed mechanically by grinding or stoning.

After the finish machining the tool should also then be given an additional temper at approx. 25°C (50°F) below the highest previous tempering temperature.

Further information is given in the Uddeholm brochure “EDM of Tool Steel”.

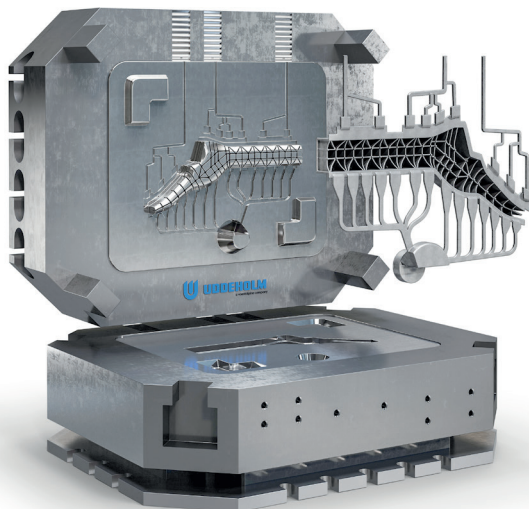

Typical example of a die casting tool for structural parts.

Manufacturing solutions for generations to come

# SHAPING THE WORLD®

We are shaping the world together with the global manufacturing industry. Uddeholm manufactures steel that shapes products used in our every day life. We do it sustainably, fair to people and the environment. Enabling us to continue shaping the world – today and for generations to come.